

TECHNICAL DATA SELECTION
 SW: 0.0.5 DB: 20181009

PROJECT N.: ..
 DATE: 22-02-2019
 PROJECT NAME:

MPI DC C

[#1] MPIDC023C0

Input data

Requested model

MPIDC023C0

Cooling

User Water Temperature In	°C	15
User Water Temperature Out	°C	10
User Glycol	%	0
Source Air Temperature	°C	27
Modulation Range	%	100

Glycol Type Selection

Glycol Type Ethylenic

Sound Inputs

Distance in free field	m	10
Direction factor		2

Altitude Inputs

Altitude above sea level m 0

UNIEN14511 Inputs

Enable calculations with UNI EN 14511		Yes
User Pumps		-

TECHNICAL DATA SELECTION
 SW: 0.0.5 DB: 20181009

PROJECT N.: ..
 DATE: 22-02-2019
 PROJECT NAME:

Output data

Requested model

MPIDC023C0

Cooling

Cooling capacity	kW	27,0
Cooling capacity [UNI 14511]	kW	26,8
Water Flow user side	l/h	4649
Water Pressure drops user side	kPa	37
Compressor power input	kW	6,2
Compressor absorbed current	A	10,0
Total Power input	kW	6,6
Total Power input [UNI 14511]	kW	6,8
Total Absorbed Current	A	11,8
EER		4,08
EER [UNI 14511]		3,94
ESEER		3,87
SEER		3,88
Available pressure head - LP Pumps (option) User side	kPa	109

Common Data

Maximum absorbed current (FLA) [without options]	A	35
Sound power level Lw (base unit)	db(A)	71
Sound pressure level Lp (base unit)	db(A)	43
Air Flow	m3/h	10400
Number of Fans		4
Fan power input	kW	0,4
Fan absorbed current	A	1,8
Compressors/Circuits		1/1
Buffer tank volume (option)	l	30
Power Supply		400 / 3+N / 50
Refrigerant		R410A
Dimensions [LxDxH]	mm	1565x560x1300
Weight without options	kg	285

Notes

The declared performances are the result of thermodynamic simulations and therefore affected by tolerances.

Please consider electrical drawing for the specific unit to design external electrical line and protection.

Calculation according to UNI EN 14511

Unit compliant to ErP2018 standard for comfort application.

DIMENSIONAL DRAWING

PROJECT N. : ..
 DATE : 22-02-2019
 PROJECT NAME :

MPI DC C
 Rif: [#1]

MPIDC_23-29

rev. 0

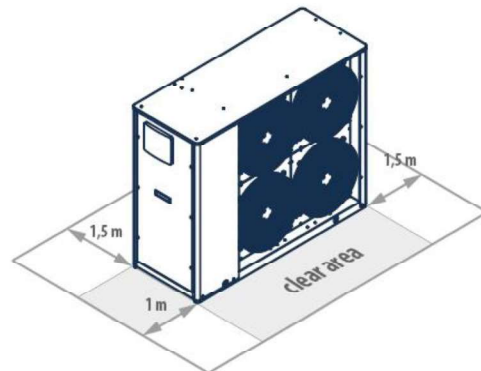
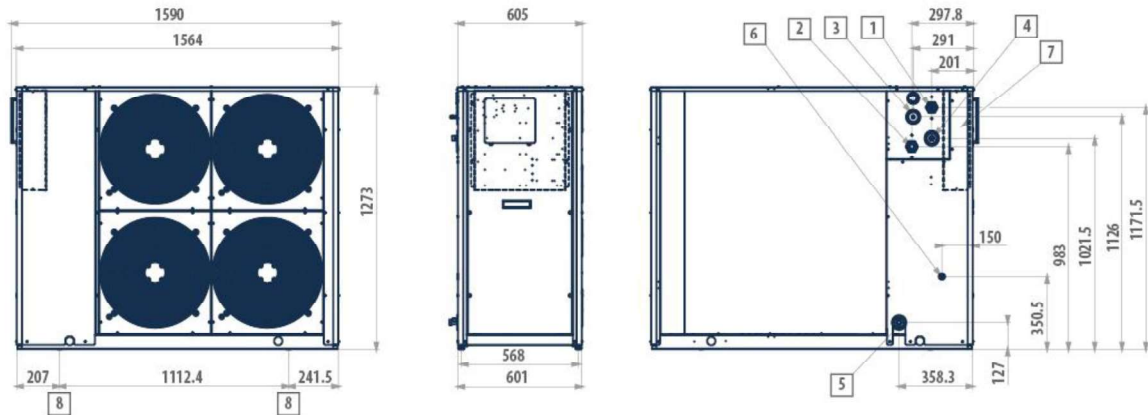

LEGEND

- | | |
|---|--|
| 1 | Water inlet ϕ 1"1/4 female |
| 2 | Water outlet ϕ 1"1/4 female |
| 3 | Safety valve discharge outlet provided with rubber ring holder |
| 4 | Water supply ϕ 1/2" male (optional tap) |
| 5 | Water drainage ϕ 1/2" female |
| 6 | Power supply ϕ 28 mm |
| 7 | Electric control board |
| 8 | Fastening points for vibration dampers (accessory) |